

**INTESTATRICE PER INFISSI**

- Motore trifase 1,1 Kw (1,5 HP) - 2800 giri/min
- Canotto porta frese Ø 32 mm
- Corsa orizzontale albero 570 mm
- Diametro max. fresa 200 mm
- Altezza massima di intestatura 140mm (160 optional)
- Larghezza massima di intestatura a 90° - 300mm
- Larghezza massima di intestatura a + 45° - 180mm
- Larghezza massima di intestatura a -45° - 180mm
- Pressione d'esercizio minima 7 ATM
- Ingombro: 146x105x130 cm
- Peso: 335 kg.

EQUIPAGGIAMENTO STANDARD:

- Cambio rapido gruppo frese
- Protezione integrale gruppo frese
- Dispositivo intestatura fuori squadra 45° 90° -45°
- Battuta stella 6 posizioni
- Nr. 1 Canotto portafrese
- Morse pneumatiche
- Lubrificazione automatica gruppo fresa
- Filtro aria
- Pistola aria
- Chiavi servizio

ACCESSORI A RICHIESTA:

- Canotto portafrese supplementare
- Kit altezza intestatura 160 mm
- Motore monofase

**PROFILES END MILLING MACHINE**

- Three-phase motor 1,1 Kw (1,5 HP) - 2800 rpm
- Cutter shaft Ø 32 mm
- Shaft horizontal stroke 570mm
- Maximum diameter of cutter 200mm
- Maximum milling height 140mm (160 optional)
- Maximum milling width a 90° - 300mm
- Maximum milling width a + 45° - 180mm
- Maximum milling width a -45° - 180mm
- Minimum working air pressure 7 bar
- Overall dimensions 146x105x130 cm
- Weight : 335 kg

STANDARD EQUIPMENT:

- Quick change of the shaft
- Safety protection hood
- Profile's reference stop tilting at 45° 90° -45°
- Depth stop 6 positions
- Nr. 1 cutters shaft
- Pneumatic clamps
- Automatic lubrication of the cutters
- Air filter
- Air gun
- Service spanners

OPTIONALS:

- Additional shaft
- Kit milling height 160 mm
- Single phase motor

**AUSLINKFRÄSMASCHINE FÜR PROFILN**

- Dreiphasig Motor 1,5 PS - 2800 U/Min
- Fräsersatzwelle Ø 32 mm
- Horizontaler Lauf der Fräsersatzwelle 570 mm
- Max. Durchmesser Fräsersatz 200 mm
- Höchsthöhe des Ausklink 140mm (160 mm auf Wunsch)
- Höchstbreite des Ausklink um 90° - 300mm
- Höchstbreite des Ausklink um + 45° - 180mm
- Höchstbreite des Ausklink um -45° - 180mm
- Druckluftanschluss 7 bar
- Abmessungen: 146x105x130 cm
- Gewicht: 335 kg

STANDARD AUSRÜSTUNG

- Schnellwechselsystem für Fräsersätze
- Vollschutzhaube des Auslinkaggregats
- Verstellbarer Anschlag 45°/90°/-45°
- Revolveranschlag mit 6 Auslinktiefen
- Fräsersatzwelle
- Pneumatische Spannung
- Sprüheinrichtung
- Wartungseinheit
- Ausblaspistole

SONDERAUSRÜSTUNG

- Zusätzliche Fräsersatzwelle
- Kit Auslinkhöhe 160 mm
- Einphasig Motor

**TUPIA PARA PERFIS**

- Motor trifasico 1,1 Kw (1,5 HP) - 2800 r.p.m.
- Eixo porta fresas Ø 32 mm
- Recorrido util eje 570 mm
- Diametro max fresas 200 mm
- Altura máxima de entestamento 140mm (160 opcional)
- Largura máxima de entestamento a 90° - 300mm
- Largura máxima de entestamento a + 45° - 180mm
- Largura máxima de entestamento a -45° - 180mm
- Fluxo pneumático de 7 bar
- Dimensões exteriores: 146x105x130 cm
- Peso bruto: 335 kg.

EQUIPAMENTO STANDARD:

- Cambio rapido do grupo de fresas
- Protecção integral do grupo de fresas
- Dispositivo fora de esquadria 45° 90° -45°
- Batente de profundidade 6 posições
- Nr. 1 Eixo porta fresas
- Apertos pneumáticos
- Sistema lubrificação automatico de cabeça
- Filtro de ar
- Pistola de ar
- Chaves de serviço

OPÇÕES:

- Eixo adicionais
- Kit altura entestamento 160mm
- Motor monofasico

**GRUGEUSE POUR PROFILS**

- Moteur triphasé 1,5 CV 2800 tpm
- Arbre porte-fraises Ø 32 mm
- Course horizontale de l'arbre 570 mm
- Diam. maxi de la fraise 200 mm
- Hauteur maxi grugeage 140mm (160 sur demande)
- Largeur maxi grugeage à 90° - 300mm
- Largeur maxi grugeage à + 45° - 180mm
- Largeur maxi grugeage à -45° - 180mm
- Pression d'exercice 7 bar
- Encombrement 146x105x130 cm
- Poids: 335 kg

EQUIPEMENT STANDARD:

- Changement rapide du groupe fraises
- Protection totale unité de grugeage
- Dispositif de pivotement guide 45°/90°/-45°
- Butée à 6 positions
- Arbre porte-fraises
- Étaux pneumatiques
- Dispositif de pulvérisation automatique groupe fraises
- Filtre de l'air
- Soufflette
- Clés de service

EQUIPEMENT SUR DEMANDE:

- Arbre porte-fraises supplémentaire
- Kit hauteur grugeage 160 mm
- Moteur monophasé

**TUPIA PARA PERFILES**

- Motore trifasico 1,1 Kw (1,5 HP) - 2800 r.p.m.
- Eje porta fresas Ø 32 mm
- Recorrido util eje 570 mm
- Diametro max. fresa 200 mm.
- Altura maxima de retestado 140mm (160 optional)
- Anchura máxima de retestado a 90° - 300mm
- Anchura máxima de retestado a + 45° - 180mm
- Anchura máxima de retestado a -45° - 180mm
- Presion de trabajo minima 7 kg/cm.
- Dimensiones: 146x105x130 cm
- Peso: 335 kg.

EQUIPAMIENTO STANDARD:

- Cambio rapido grupo fresas
- Protección integral grupo fresas
- Dispositivo por retestar fuera de esquadra 45° 90° -45°
- Tope de profundidad 6 posiciones
- Nr. 1 Eje porta fresas
- Mordazas neumáticas
- Lubricación automática del las cabeza
- Filtro de aire
- Pistola de aire
- Llaves de servicio

OPCIONALES:

- Eje porta fresas adicional
- Kit altura retestado 160 mm
- Motor monofasico

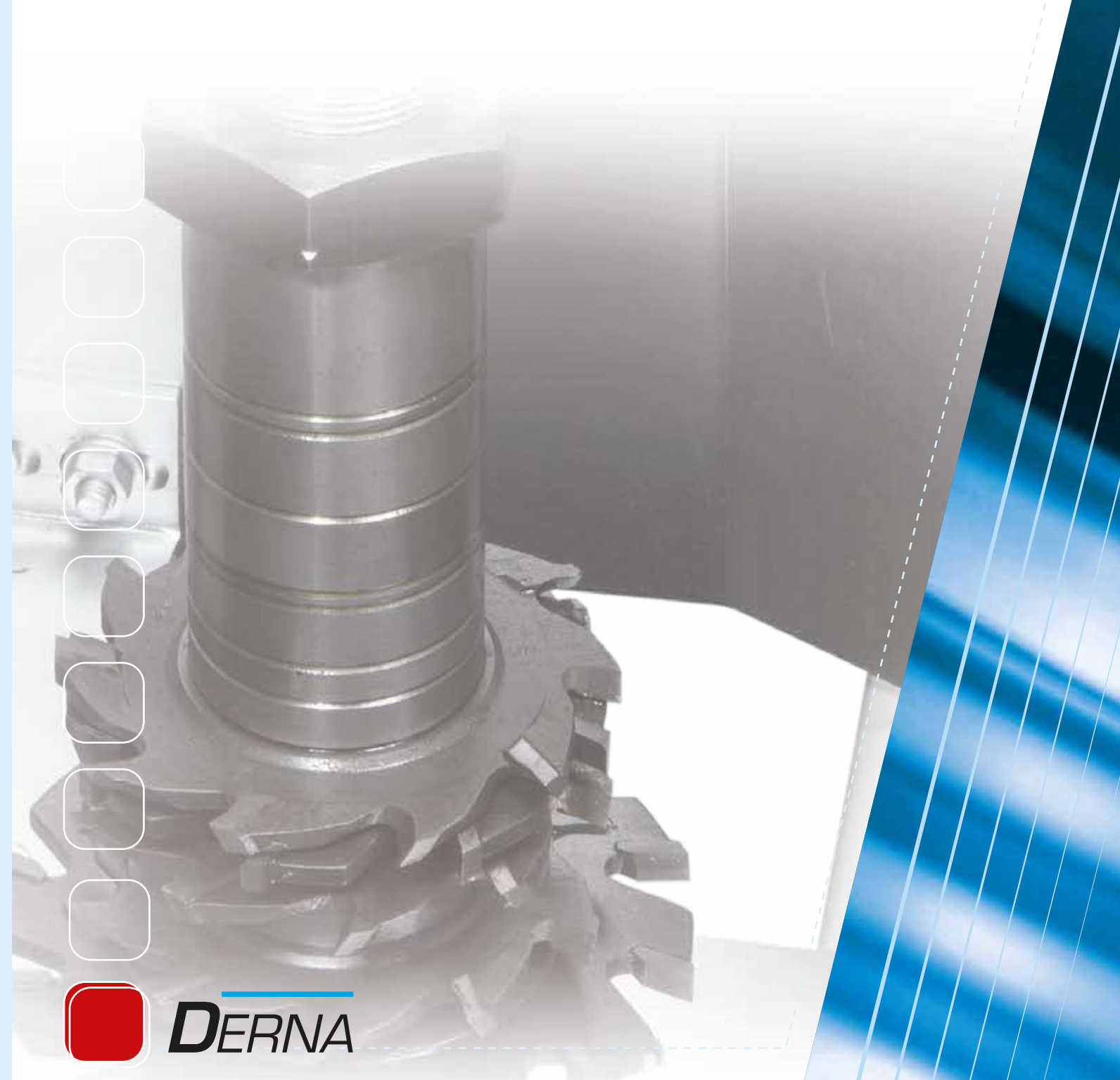

Macchine per la lavorazione dell'alluminio e del pvc
Aluminium and pvc working machinery

**INTESTATRICE PER INFISSI**

PROFILES END MILLING MACHINE

GRUGEUSE POUR PROFILS

AUSLINKFRÄS MASCHINE FÜR PROFILN

TUPIA PARA PERFILES

TUPIA PARA PERFIS



Via Togliatti, 81 - 47826 Villa Verucchio (RN) - Italy
Tel. 0541/677315 - Fax 0541/678752
www.lgf.it - info@lgf.it





Dispositivo intestatura fuori squadra 45°-90°-45°
 Profile reference stop tilting at 45° 90° -45°
 Dispositif de pivotement guide 45° 90°-45°
 Verstellbarer Anschlag 45° 90°-45°
 Dispositivo por restestar fuera de esquadra 45° 90°-45°
 Dispositivo fora de esquadria 45° 90°-45°





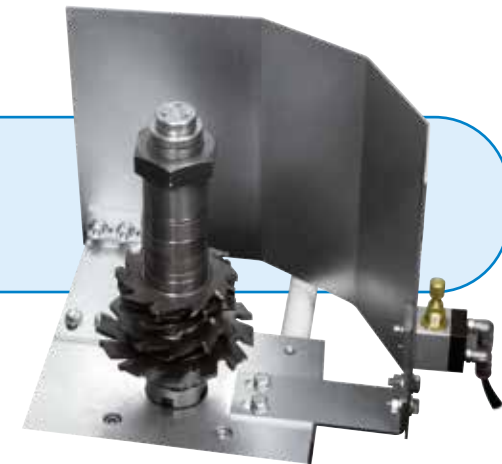



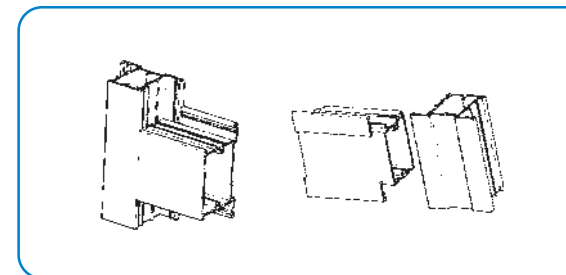
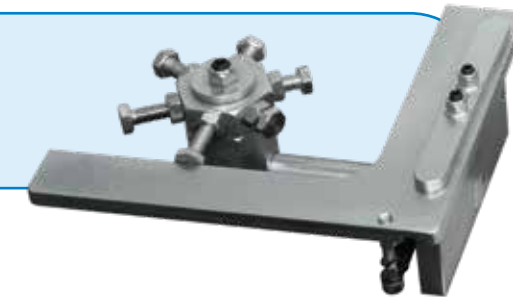

Canotto portafrese
 Cutter shaft
 Arbre porte fraises
 Fräsersatzwelle
 Eixo porta fresas
 Eje porta fresas

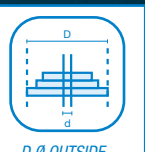
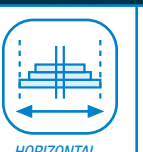

Battuta stella 6 posizioni
 Depth stop 6 positions
 Boutée de profondeur 6 positions
 Anschlag mit 6 Tiefen
 Tope de profundidad 6 posiciones
 Baténte de profundidade 6 posições

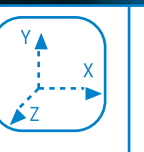
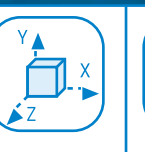

										
DERNA M DERNA A	MOTOR MOTORE	THREE-PHASE A TRE FASI	MOTOR RPM RPM DEL MOTORE	D Ø OUTSIDE d Ø INSIDE D Ø ESTERNO d Ø INTERNO	HORIZONTAL STROKE OF SHAFT CORSA ORIZZONTALE ALBERO	OPERATING PRESSURE PRESSIONE DI FUNZIONAMENTO	AIR CONSUMPTION CONSUMO D'ARIA	DIMENSIONS CM DIMENSIONI CM	PACKAGING CM IMBALLAGGIO CM	WEIGHT PESO
	1,8 Kw	400V - 50 Hz	2800 RPM	200/32	570 mm.	7 bar	34 45 lt/ciclo	146x105x130	154x109x144	335

*Le misure ed i pesi sono approssimativi. La Ditta si riserva di apportare le migliori e modifiche senza alcun preavviso.
 Les dimensions et les poids sont approximatifs. La maison peut apporter des améliorations et des modifications sans aucun préavis.
 Weights and dimensions of machine, as well as performances, can be changed or modified at any time without notice.
 Konstruktions- und Massänderungen bleiben vorbehalten.
 A média e o peso são aproximados. A empresa pode modificar sem qualquer aviso.
 Las medidas y pesos son aproximados. La empresa se reserva el derecho de modificarlas sin previo aviso.*